



Radio data logger system · testo Saveris 2

Instruction manual



1 Contents

1	Contents	3
2	System	5
2.1	System overview	5
3	First steps	6
4	Offline Konfiguration	7
5	Licences	8
6	WiFi data logger	9
6.1	Technical data	9
6.1.1	Measurement-specific data	9
6.1.2	General data	10
6.1.3	WiFi-specific data	11
6.1.4	Technical data for a secure wireless LAN	11
6.2	Safety and the environment	12
6.2.1	General safety instructions	12
6.2.2	Safety instructions for patients with a cardiac pacemaker or implanted cardiac pacemaker	13
6.2.3	Batteries	13
6.2.4	Protecting the environment	13
6.3	Wall bracket	14
6.4	Display and control elements	16
6.4.1	Overview	16
6.4.2	Display icons	16
6.4.3	LED display – configuration	17
6.4.4	LED display – operation	18
7	User interface	19
8	Dashboard	20
8.1	Measuring points	20
8.2	Active alarms	20
9	Analysis & reports	20
9.1	Automatic reports	20
10	Alarms	22
10.1	Alarm list	22
10.2	Alarm settings	22
10.3	System warnings	23
11	Configuration	25
11.1	Users	25
11.2	User roles	26

11.3 Account ID	26
11.4 Measuring point groups	27
11.5 Areas	28
11.6 WiFi data loggers.....	28
11.7 Firmware updates.....	29
12 User management	30
12.1 User settings.....	30
12.2 Account information	30
12.3 Change password.....	30
12.4 Logoff	30
13 Command bar	31
13.1 Open Quick Start Guide	31
13.2 Open Online Help	31
13.3 Open system messages	31
14 System and status information	31
14.1 Display system status.....	31
15 Frequently Asked Questions.....	32
16 Approvals and Certification.....	37

2 System

2.1 System overview

The testo Saveris 2 WiFi data logger system is the modern solution for monitoring temperature and humidity values in storerooms and work rooms.

The system consists of WiFi data loggers and a Cloud data storage system. The testo Saveris 2 WiFi data loggers record temperature and humidity reliably at adjustable intervals and transmit the readings directly to the Testo Cloud via WLAN. The readings stored in the Cloud can be analyzed at any time, anywhere, using an internet-enabled smartphone, tablet or PC. Limit value violations are immediately reported via e-mail, or optionally via SMS.

Similarly, WiFi data loggers can be programmed via the Testo Cloud and analyses set up.

Record readings with WiFi data loggers

WLAN router (at customer site)

Save the readings in the Testo Cloud

Call up readings on any terminal device: PC, smartphone, tablet

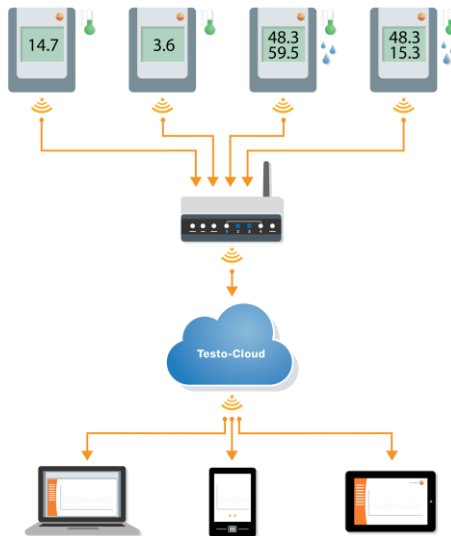

3 First steps

1. Take the data logger out of the packaging.
2. Remove the data logger from the wall bracket. (see chapter 6.3)
3. Loosen the battery cover by slightly undoing the screws on the back of the housing.
4. Remove the insulation strips from the battery compartment.
The data logger is now activated.
5. Tighten the screws on the back of the housing back up.

The Quick Start Guide is provided to assist you when you take your first steps with commissioning the testo Saveris 2.

It can help you with logging in WiFi data loggers.

- In the command bar, click on the icon  to open the **Quick Start Guide**.



Note for testo Saveris 2-T2:

Before integrating the testo Saveris 2-T2, the probe(s) must already be connected to the data logger.

If a different probe is connected to the device, you must log off the data logger in the cloud and start up the logger again with the changed probe configuration.

4 Offline Konfiguration

As an alternative to creating the configuration file in the Quick Start Guide with subsequent download of the XML configuration file, the WiFi data logger can also be configured via a PDF form.



Note

You need the Adobe Reader program (version 10 or later) to use the PDF form correctly. If you have not installed Adobe Reader, you can go to the following address to download it free of charge:

<http://get.adobe.com/reader/>

1. Connect the WiFi data logger to the PC.
2. Open the file **WifiConf.pdf** on the external drive **SAVERIS 2**.
3. Copy your Account ID and paste it into the relevant field on the PDF form. You will find the Account ID in the testo Saveris 2 software under **Configuration -> Account ID**.
4. Enter the **Network name (SSID)** and, if necessary, your **WLAN password** in the relevant fields on the PDF form.
5. Click on the **Save configuration** button.
A dialogue box opens for exporting the form data.
6. Select the external drive **SAVERIS 2** as the storage location and save the form data (configuration file **WiFiConf_Daten.xml**) on it.
7. Disconnect the USB connection to the PC to complete the configuration of the logger.



Note

You can also save the configuration file locally on your computer and configure other WiFi data loggers even faster by simply copying the XML configuration file onto their external drive (**Saveris 2**).

5 Licences

Purchase licence

By clicking on the licence display in the header you will be redirected to the licence shop. Here you can choose and purchase your licence expansion.

Or

Click on the symbol next to the inactive measuring function  Upgrade. This also opens the licence shop to expand your licence.

6 WiFi data logger

6.1 Technical data

6.1.1 Measurement-specific data

WiFi data logger	T1	T2	T3	H1	H2
Order number	0572 2031	0572 2032	0572 2033	0572 2034	0572 2035
Sensor type	1x NTC internal	2x NTC or door contact external	2x thermocouple type K/J/T external	1x NTC/humidity internal	1x NTC/humidity external
Measuring range	-30 to +50 °C	-50 to +150 °C	K: -195 to +1350 °C J: -100 to +750 °C T: -200 to +400 °C	-30 to +50 °C 0 to 100% RH ¹	Probe-specific
Accuracy ±1 digit	± 0.5 °C	± 0.3 °C	± (0.5 °C + 0.5% of reading)	± 0.5 °C ±2.0 %RH (at +25 °C, 0 to 90% RH) ±0.03 %RH/K (k=1) ±1 %RH hysteresis ±1 %RH/year drift	Probe-specific
Resolution	0.1 °C	0.1 °C	0.1 °C	0.1 °C 0.1% RH	Probe-specific



Note

Saveris 2 WiFi data loggers are supplied with a factory calibration certificate as standard. In many applications, it is recommended that you recalibrate the loggers every 12 months. This can be carried out by Testo Industrial Services (TIS) or other certified service providers with the aid of easy-to-use service software. Please contact Testo for further information.

6.1.2 General data

WiFi data logger	T1	T2	T3	H1	H2
Order number	0572 2031	0572 2032	0572 2033	0572 2034	0572 2035
Operating temperature	-30 to +50 °C				
Storage temperature (without batteries)	-40 to +70 °C				
Storage temperature (with supplied batteries)	+10 to +50 °C				
Storage temperature (with Energizer, Li-Ion batteries)	-40 to +60 °C				
Protection class	IP 65	IP 65	IP 54	IP 30	IP 54
Measuring cycle	1 min ¹ to 24 h (15 minutes default)				
Communication cycle	1 min to 24 h (15 minutes default)				
Memory	10,000 readings/channel				
Battery life	<p>24 Months*</p> <ul style="list-style-type: none"> • + 25 ° C (AA alkaline-manganese mignon cells) <ul style="list-style-type: none"> • Measuring cycle: 15 min • Communication cycle: day (8 h) 15 min & night (16 h) 90 min <ul style="list-style-type: none"> • At -30 ° C (lithium batteries 0515 0572) <ul style="list-style-type: none"> • Measuring cycle: 15 min • Communication cycle: day (8 h) 15 min & night (16 h) 90 min <p>* All information depends on network connection</p>				
Voltage supply	<p>4 x AA AIMn batteries</p> <p>Mains unit optional</p> <p>for temperatures below +10 °C please use Energizer batteries 0515 0572</p>				
Dimensions	95 x 75 x 30.5 mm	95 x 75 x 30.5 mm	95 x 75 x 30.5 mm	115 x 82 x 31.5 mm	95 x 75 x 30.5 mm
Weight (including batteries)	240 g				
EN 12830-certified	Yes	Yes	No	No	No
Door contact	No	Optional	No	No	No

¹ depending on the licence purchased

WiFi data logger	T1	T2	T3	H1	H2
Order number	0572 2031	0572 2032	0572 2033	0572 2034	0572 2035
Wall bracket	Included in delivery				



Note

Please note that for EN 12830, annual checking and calibration must be carried out as specified in EN 13486. Contact us for more information.

6.1.3 WiFi-specific data

WiFi data logger	T1	T2	T3	H1	H2
Order number	0572 2031	0572 2032	0572 2033	0572 2034	0572 2035
Radio frequency	2.4 GHz (IEEE 802.11 b/g/n/x)				
General encryption method	WEP, WPA (TKIP), WPA2 (TKIP, AES, CCMP)				
WPA2 Enterprise	EAP-TLS, EAP-TTLS-TLS, EAP-TTLS-MSCHAPv2, EAP-TTLS-PSK, EAP-PEAP0-TLS, EAP-PAP0-MSCHAPv2, EAP-PEAP0-PSK, EAP-PEAP1-TLS, EAP-PEAP1-MSCHAPv2, EAP-PEAP1-PSK				

6.1.4 Technical data for a secure wireless LAN

Ports

The testo Saveris 2 WiFi data loggers use the MQTT protocol, which communicates via port TCP 1883² or 8883³.

These UDP port approvals are also required:

- Port 53 (DNS name resolution)
- Port 123 (NTP time synchronization)

All ports must be able to communicate only externally to the Cloud. No bi-directional port approvals are necessary.

² For item numbers: 0572 2001, 0572 2002, 0572 2003, 0572 2004, 0572 2005

³ For item numbers: 0572 2031, 0572 2032, 0572 2033, 0572 2034, 0572 2035

Ping

The default gateway, which is communicated to the probe via DHCP or manually, must answer the PING request of the WiFi data logger.



Note

During the first configuration, it is possible to select whether DHCP or Static IP is used (select expert mode for the corresponding information)

testo Saveris 2 application

The testo Saveris 2 application is accessible via a normal, up-to-date browser (www). The standard TCP ports http (80) and https (443) are used.

6.2 Safety and the environment

6.2.1 General safety instructions

- Only operate the product properly, for its intended purpose and within the parameters specified in the technical data. Do not apply any force.
- Do not commission the instrument if there are signs of damage on the housing.
- Only use accessories and probes configured for Saveris 2.
- Dangers may also arise from the systems being measured or the measuring environment: always comply with the locally valid safety regulations when carrying out measurements.
- Temperature information given on probes relates only to the measuring range of the sensor technology. Do not expose handles and feed lines to temperatures in excess of 70°C (158°F), unless they are expressly authorized for use at higher temperatures.
- Do not perform any contact measurements on uninsulated, live parts.
- Do not store the product together with solvents. Do not use any desiccants.
- Only carry out maintenance and repair work on this instrument described in the documentation. Follow the prescribed steps exactly. Use only original spare parts from Testo.

6.2.2 Safety instructions for patients with a cardiac pacemaker or implanted cardiac pacemaker

- Handle the magnetic plate on the wall bracket with care and keep it in a safe place.
- Maintain a distance of 20 cm between your implant and the magnetic plate on the wall bracket.

6.2.3 Batteries

- Improper use of batteries may cause the batteries to be destroyed, or lead to injury due to current surges, fire or escaping chemicals.
- Only use the batteries supplied in accordance with the instructions in the instruction manual.
- Do not short-circuit the batteries.
- Do not take the batteries apart and do not modify them.
- Do not expose the batteries to heavy impacts, water, fire or temperatures in excess of 60 °C.
- Do not store the batteries in the proximity of metal objects.
- In the event of contact with battery acid: rinse affected areas thoroughly with water, and if necessary consult a doctor.
- Do not use any leaky or damaged batteries.

6.2.4 Protecting the environment

- Dispose of spent batteries in accordance with the relevant legal specifications.
- At the end of its useful life, deliver the product to the separate collection point for electric and electronic devices (observe local regulations) or return the product to Testo for disposal.

6.3 Wall bracket



Note

The data loggers must only be mounted vertically. Here, the connections must point downwards. In the case of data loggers with a display, you need to pay attention to the reading direction. Otherwise, the measuring accuracy might be diminished.

The wall bracket ensures that the WiFi data logger is kept securely in place. Mounting materials are not included in the scope of delivery. Select mounting materials that are appropriate for the required mounting location.

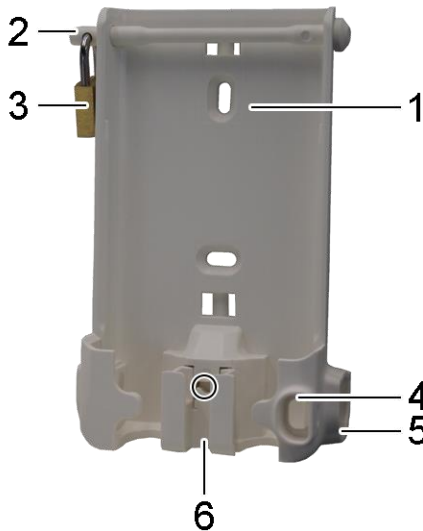

(Suitable for: 0527 2001, 0527 2002, 0527 2003, 0527 2004, 0527 2005, 0527 2031, 0527 2032, 0527 2033, 0527 2035)

- 1 Wall bracket with notches for mounting materials (screws or cable ties)
- 2 Safety bolt
- 3 Lock
- 4 Storage compartment for USB port sealing plug
- 5 Storage compartment for probe socket sealing plug (left/right)
- 6 USB cable holder, folding: push down on the spot marked with a circle using a screwdriver and slide cable holder downwards.



(Suitable for: 0572 2034)

- 1 Wall bracket
- 2 Data logger
- 3 Unlocking tool
- 4 Magnetic plate (optionally available, order number: 0554 2001)

- Insert the unlocking tool into the unlocking opening.
- Pull the data logger up and out of the wall bracket.

6.4 Display and control elements







6.4.1 Overview



- 1 Display
- 2 Alarm LED, flashes red in the event of an alarm
- 3 QR code, for direct access to the instrument data in the Testo Cloud
- 4 Control key, to manually start data transfer
- 5 Battery compartment (on rear)
- 6 USB and probe sockets (on the bottom, instrument-specific)

6.4.2 Display icons

Icon	Description
	Battery capacity 75% to 100%
	Battery capacity 50% to 74%
	Battery capacity 25% to 49%
	Battery capacity 5% to 24%, icon flashes: battery capacity < 5%
	External power supply (via USB port)
	WLAN signal strength 100%

Icon	Description
	WLAN signal strength 75%
	WLAN signal strength 50%
	WLAN signal strength 25%
	Data connection to the Testo Cloud exists, icon flashes: Data connection to the Testo Cloud being established
	Alarm message
1	Measurement channel 1
2	Measurement channel 2
	Alarm status: upper limit value exceeded
	Alarm status: lower limit value undershot

6.4.3 LED display – configuration

LED display	Description
Online data logger gives a short (200 ms) green flash every 30 seconds.	Online data logger is in standby mode, there is no configuration stored in the online data logger yet.
Online data logger flashes green at one-second intervals.	Online data logger is in configuration mode and can be configured within 5 minutes after activation.
Online data logger gives 3 long red flashes after configuration.	SSID/account ID is not correct.
Online data logger gives 1 long (1 sec.) red flashes.	Online data logger was not configured within 5 minutes.
Online data logger gives 2 long red flashes after configuration.	Online data logger is not connected to the access point.
Online data logger gives 2 short green flashes.	Configuration was successful, online data logger is connected to the Cloud and is switching to measuring mode.

6.4.4 LED display – operation

LED display	Description
Online data logger which is already configured gives 2 short red flashes.	Online data logger is not connected to the access point, measurement data cannot be transmitted to the Cloud.
Online data logger gives 1 long green flash.	The online data logger has carried out a measurement.
Online data logger gives 1 long red flash.	An alarm was detected by the online data logger.
Online data logger gives 2 short green flashes.	Measurement data was successfully transmitted to the Cloud, logger is back in the measuring cycle.
Online data logger gives 4 long red flashes.	Briefly (< 1 sec) press the button on the front of the logger. If the online data logger flashes red 4 times again, the batteries are spent and need to be replaced.
Online data logger flashes alternately red / green.	A firmware update is being carried out.

7 User interface

The screenshot shows the testo Saveris 2 user interface. At the top, there is a dark header bar with the logo and 'testo Saveris 2' on the left, and 'System status' with a red notification bell icon (labeled 1) and user management icons (labeled 2 and 3) on the right. Below the header is a light grey menu bar with 'Dashboard' (labeled 4), 'Analysis & reports -', 'Alarms -', and 'Configuration -'. The main content area is divided into two sections: 'Measuring points' and 'Active alarms' (labeled 5). The 'Measuring points' section contains a table with columns for Status, Measuring point, Measuring point group, Last value, and Last measurement. It shows two entries: one with a red bell icon and another with a green checkmark. Below the table is a 'WiFi data logger details' section for 'H2_45800848' with sub-sections for WiFi, Battery, External power supply, Serial number, and Details. The 'Active alarms' section shows a red warning triangle icon and details for an 'Alarm: Overshooting' event.

Status	Measuring point	Measuring point group	Last value	Last measurement
	H2_45800848	Office_2	24.9°C 46.8%rF 12.8°C Id 10.7g/m³	18/03/15 15:11:32
	H1_45801022	Office_1	24.7°C 46.0%rF 12.3°C Id 10.4g/m³	18/03/15 15:12:54

Stat...	Details
	18/03/15 15:11:32 Alarm: Overshooting (24.9°C > 24.3°C) H2_45800848 / Office_2

1. System and status information
2. Command bar
3. User management
4. Menu bar with the main menus:
 - Dashboard
 - Analysis & reports
 - Alarms
 - Configuration
5. Display area

8 Dashboard

The dashboard is the home page. It provides an overview of the key system data: **Measuring points** and **Active alarms**.

8.1 Measuring points

A summary of all measuring points is displayed.

Click on the icon ► to display more information.

8.2 Active alarms

A summary of all active alarms and system warnings is displayed. Unread alarms and system warnings are shown in **bold**.

Click on the icon ► to display more information.

On displaying the detailed information, the alarm message/system warning is marked as "read" and the alarm counter is marked down.

9 Analysis & reports

9.1 Automatic reports

Automatic reports are regularly generated automatically by the system (Generated reports), according to the settings specified by the user (Report settings).

Creating an automatic report

1. Click on the **Create an automatic report** button.
2. Enter the data required for creating the automatic report.

The following settings can be defined and edited:

- **Name of the report:** designation of the automatic report.
- **Measuring points for the report:** measuring points that are to be covered in the report. Click on the checkbox in front of the channel designation.
- **How often is the report to be created?:** interval at which the reports are to be generated. Select a report cycle from the drop-down menu.
- **File format:** file format in which the reports are to be generated. Select a file format from the drop-down menu.
- **Data views:** data views in which the data in the reports is to be displayed. Click on the checkbox in front of the data view designation.

- **Also send report via e-mail:** as well as saving reports under **Generated reports**, these can also be sent as e-mails. Click on the checkbox to open the input screen for e-mail addresses.
3. Click on the **Create an automatic report** button.

The first report will be created on the following day.

Generated reports

A summary of the reports already generated is displayed.

Click on the icon  to display more information.

- Click on the **Download** button to download a report.
- Click on the **Edit this report series** button to display and edit the settings.

Report settings

Automatic reports which have already been created are displayed in a table.

- Click on the **Actions** button and then on **Edit** to display and edit the settings.
- Click on the **Actions** button and then on **Delete** to delete the automatic report.

10 Alarms

10.1 Alarm list

Display of alarms

A summary of all triggered alarms and system warnings is displayed. Unread alarms and system warnings are shown in **bold**.

The display can be filtered according to the following characteristics:

- By measuring point group/measuring point: click on the checkbox in front of the measuring point group/measuring point.
- By date/time: click on the start date/end date and select the start date/start time and end date/end time.

Detailed information on alarms

Click on the icon ► to display more information.

On displaying the detailed information, the alarm message/system warning is marked as "read" and the alarm counter is marked down.

Click on the **Mark all as read** button to mark all alerts as "read".

10.2 Alarm settings

Creating and displaying alarm settings

- Click on the **+ New alarm setting** button to create a new alarm setting.

Existing alarm settings are displayed below the button.

- Click on the title of an alarm setting to display it.

Configuring and editing a displayed alarm setting

The following settings can be defined and edited:

- **Title:** designation of the alarm setting (required field).
- **Measuring points:** Measuring point group/measuring point which is to be monitored. Click on the checkbox in front of the measuring point group/measuring point.
- **Alarm limit value 1 and 2:** Different limit value ranges which can be defined for different periods.
- **Upper limit, lower limit:** Are values which are to be monitored.
- **Alarm delay:** Minimum duration of a limit value violation before an alarm is triggered.



The time intervals between measurements (measurement rate should be smaller than the alarm delay (e.g. measurement rate = 5 minutes, alarm delay = 15 minutes)).

- **Timed control:** Define individual alarm periods for which the alarm limit values 1 and 2, or no alarm at all, apply. To define the alarm value 1 and 2, double-click on a time point in the table or pull open the desired time period with the mouse. In periods in which the the table is left empty, you receive no alarm.



If you have not defined alarm periods, the alarm limits will be active 24 hours a day.

If alarm periods have been defined, the limit value alarms are active only in the marked period.

- **Channel alarms:** alarms in the event of a defective sensor.
- **E-mail recipient:** addressees who are informed when an alarm occurs. Click on the checkbox in front of the recipient or enter the name and e-mail address of other recipients and click on the **+ Add** button.
- **SMS recipient:** addressees who are informed when an alarm occurs. Click on the checkbox in front of the recipient or enter the name and mobile phone number of other recipients and click on the **+ Add** button.
- **Save:** click on the button to save the settings.
- **Delete:** click on the button to delete the alarm setting.

10.3 System warnings

Creating and displaying system warnings

- Click on the **+ New system warning** button to create a new system warning.

Existing system warnings are displayed below the button.

- Click on the title of a system warning to display it.

Configuring and editing a displayed system warning

The following settings can be defined and edited:

- **Title:** designation of the system warning (required field).
- **Battery almost discharged:** monitor the WiFi data logger for discharged battery.
- **Power supply interrupted:** monitor the external power supply of the WiFi data logger for interruptions.

- **WiFi data logger is not responding:** monitor the WiFi data logger for data transmission failure. Click on the **Activate** button and configure the monitoring cycle using the slide control.



Note

The set time should be greater than the WiFi data logger's communication cycle.

- **WiFi data logger:** measuring point group/measuring point which is to be monitored. Click on the checkbox in front of the measuring point group/measuring point.
- **E-mail recipient:** addressees who are informed when an alarm occurs. Click on the checkbox in front of the recipient or enter the name and e-mail address of other recipients and click on the **+ Add** button.
- **SMS recipient:** addressees who are informed when an alarm occurs. Click on the checkbox in front of the recipient or enter the name and mobile phone number of other recipients and click on the **+ Add** button.
- **Save:** click on the button to save the settings.
- **Delete:** click on the button to delete the system warning.

11 Configuration

11.1 Users

Users can be created and managed.

Standard users

By default, two users are created in the system:

- Account Owner (name can be changed), with Administrator user role (role cannot be changed).
- Testo Support (name can be changed), with Testo User Support user role (role cannot be changed).

Creating and editing new users

Other users with different User roles can be created and edited.

- Click on the **Add a new user** button to create a new user.

Existing users are displayed in a list.

- Click on the name of a user to display the settings.
- Click on the **Edit** button to change the settings.

The following settings can be defined and edited:

- **Title:** title of the user.
- **First name:** first name of the user (required field).
- **Second name:** second name of the user.
- **Surname:** surname of the user (required field).
- **Password** and **Repeat password:** user password. The user password, can be changed by the user at a later stage.
- **User role:** defines the user permissions within the system.
- **E-mail address & login:** e-mail address of the user. The e-mail address is also the login name. The e-mail address is also used for system notifications (alarms, system warnings).
- **Change e-mail address & login** (field is only available when editing the user account of the account holder): Enter a new e-mail address. Entering a new e-mail address also changes the login name.
- **Mobile number:** telephone number of the user, this is used for system notifications (alarms and system warnings).
- **Active from:** date from which the user is active.
- **Active to:** date up to which the user is active.

- **Details:** text field for entering other user-specific information.
- **Save:** click on the button to save the settings.

11.2 User roles

A description of the available user roles can be displayed.

- Click on the title of a user role to display a description of it.

Users have different permissions depending on their allocated user role:

Permissions	Administrator	Analyst	Auditor	Operator
Display created users	x	x	x	x
Create, edit and delete users	x	-	-	-
Display Account ID	x	-	-	x
Login WiFi data loggers	x	-	-	x
Configure and deactivate WiFi data loggers	x	-	-	x
Create, edit and delete areas	x	-	-	x
Display, create, edit and delete alarm settings and system warnings	x	-	-	x
Read and analyze readings	x	x	x	x
Display details about alarms and system warnings (= mark alarms and system warnings as read)	x	x	x	x
Create automatic reports	x	-	-	x

x = available, - = not available

11.3 Account ID

The Account ID is the unique address of your user account in the Testo Cloud. This is needed to configure the WiFi data loggers in order to ensure that they send your data to the correct user account.

11.4 Measuring point groups

Measuring points can be organized into measuring point groups.

Assigning measuring points to a measuring point group (e.g. Room 1, Room 2, etc.) makes the administration of multiple measuring points easier.



Creating and editing a measuring point group

- Click on the **New measuring point group** button to create a new measuring point group.

Measuring point groups already created are displayed in a list.

- Click on the **Actions** button and then on **Edit** to display and edit the settings.

The following settings can be defined and edited:

- **Title:** designation of the measuring point group (required field).
- **Description:** description of the measuring point group.
- **Area:** area that the measuring point group is to be assigned to.
- **Measuring points:** available measuring points and those assigned to the measuring point group are displayed. Click on the icon  to assign a measuring point to the group. Click on the icon  to delete a measuring point from the group.
- **Save:** click on the button to save the settings.
- **Delete:** click on the button to delete the measuring point group.

Deleting a measuring point group

- Click on the **Actions** button and then on **Delete** to delete the measuring point group.

11.5 Areas

Measuring point groups can be organized into areas.

Creating and editing an area

- Click on the **New area** button to create a new area.
Areas already created are displayed in a list.
- Click on the **Actions** button and then on **Edit** to display and edit the settings.
The following settings can be defined and edited:
 - **Display name:** designation of the area (required field).
 - **Description:** description of the area.
 - **Save:** click on the button to save the settings.
 - **Delete:** click on the button to delete the area.

Deleting an area

- Click on the **Actions** button and then on **Delete** to delete the area.

11.6 WiFi data loggers

A summary of all WiFi data loggers logged on is displayed.

- Click on the **Details** button to display more information.
- Click on the **Deactivate** or **Activate** button to deactivate or activate WiFi data loggers.

Configuring a WiFi data logger

- Click on the **Configure** button to change the configuration.
The following settings can be defined and edited:
 - **Name of the WiFi data logger:** designation of the WiFi data logger (required field). Condition at delivery: **Model_Serial number**
 - **Description:** description of the WiFi data logger.
 - **Select battery type:** set the battery type used. For the battery capacity to be displayed correctly, the correct battery type must be selected.
 - **Display:** switch the display of the WiFi data logger on or off.
 - **Name of the measuring point:** designation of the measuring point (required field).
 - **Measuring cycle:** interval at which readings are obtained. Set the measuring cycle using the slide control.
 - **Day communication cycle** and **Night communication cycle:** interval at which readings are transmitted to the Testo Cloud. Select the start time for

the day communication cycle and the night communication cycle. Set the communication cycle using the slide control.

- **Channel name:** designation of the measurement channel (required field). Condition at delivery: **Model_Serial number_Channel number**
- **Select unit:** unit in which the readings are displayed.
- **Select sensor type** (only for model T2, T3): sensor type used by the measurement channel.
- **Save:** click on the button to save the settings.
- **Deactivate** or **Activate:** click on the button in order to deactivate or activate measurement channels or WiFi data loggers.
- **Remove:** click on the button in order to log WiFi data loggers off the system.

11.7 Firmware updates

A list with available firmware updates for the WiFi data loggers is displayed. Firmware updates can be installed on the data loggers via WiFi.

- Click on the **Activate** button to install a firmware update.

12 User management

The user management provides information and settings options for the user account.

- Click on the icon  to open the **User menu**.

12.1 User settings

User-specific settings can be made.

- **Language:** select the language of the user interface.
- **Time zone:** select the time zone for the date and time display.
- **Save:** click on the button to save the settings.

12.2 Account information

Information about your Saveris 2 account is displayed.

12.3 Change password

The user password can be changed.

New password and **New password (repeat):** enter new password in both text fields.

- **Save:** click on the button to save the settings.



Note

It is not possible to change the user name (e-mail address).

12.4 Logoff

The user is logged off the system.

- **Logoff:** click on the text to log off.

13 Command bar

13.1 Open Quick Start Guide

The Quick Start Guide can help you with logging in WiFi data loggers.

- Click on the icon  to open the **Quick Start Guide**.

13.2 Open Online Help

The Online Help (this document) provides support for issues related to the product components.

- Click on the icon  to open the **Online Help**.

13.3 Open system messages

The system messages contain important information relating to the product.

- Click on the icon  to open the **System messages**. The number of unread system messages is displayed above the icon.

A summary of all system messages is displayed. Unread system messages are shown in **bold**.

- Click on the title of a system message to display more information.

On displaying the detailed information, the system message is marked as "read" and the message counter is marked down.

14 System and status information

14.1 Display system status

Displays the alarm status.



: no alarms active



: alarms active, number of unread alarms is displayed

- Click on the icon to open the **Alarm list**.

15 Frequently Asked Questions

Can the WiFi data logger be connected to the PC using any USB cable?

We recommend that you use the USB cable supplied with the WiFi data logger to guarantee stable data transmission. Longer USB cables are suitable for the power supply only.

Can the WiFi data logger also be used in networks with WPA2 Enterprise encryption?

Second-generation Saveris 2 loggers* can be used in networks with the following WPA2 Enterprise encryption methods.

EAP-TLS, EAP-TTLS-TLS, EAP-TTLS-MSCHAPv2, EAP-TTLS-PSK, EAP-PEAP0-TLS, EAP-PAP0-MSCHAPv2, EAP-PEAP0-PSK, EAP-PEAP1-TLS, EAP-PEAP1-MSCHAPv2, EAP-PEAP1-PSK

To integrate the loggers into the WPA2 Enterprise network, proceed as follows:

1. Open the .PDF file stored on the logger and generate a corresponding .XML file by selecting the programming options step by step.
2. Copy your company-specific WPA2 Enterprise certificates and the generated .XML file to the logger's mass storage via USB using drag & drop.
3. Please pay special attention to the correct spelling and to the suffixes of certificate names.

ca.pem, client.pem, private.key

Check whether the certificate is available in a PEM or BASE64 format. To do so, open the certificate using a text editor and check that you can see the string "-----BEGIN CERTIFICATE-----". If you cannot see this string, the IT department or the user must explicitly export the certificate from the Radius server using BASE64, or convert it using openssl. There must be one certificate only, not a bundle, inside the file.

4. Please note that the configuration of the WiFi data logger will only be fully transferred once the USB connector has been removed.

* Item number: 0572 2031, 0572 2032, 0572 2033, 0572 2034, 0572 2035

The XML configuration file is not being applied by the WiFi data logger, what can I do?

Depending on the operating system, there may be difficulties with the data transfer if the configuration file name has been changed. Leave the default file name.

The WiFi data logger's wireless connection to the access point was interrupted, what can I do?

- Press the control key on the WiFi data logger to start searching for a WLAN connection manually.

- Change the alignment or position of the WiFi data logger or the access point (WLAN router).

The WiFi data logger is displaying the error code E03, E04, E05 or E09, what can I do?

An error has occurred in the WiFi data logger. The error will automatically be corrected by the firmware of the WiFi data logger. After a few seconds the error code should no longer be displayed, you do not need to do anything.

The WiFi data logger is displaying the error code E12, what can I do?

The configuration file **WifiConfig.xml** indicates an error. Use the **Quick Start Guide** to create a new configuration file and save this onto the WiFi data logger.

The WiFi data logger is displaying error code E20, what can I do?

A WPA2 Enterprise EAP connection needs to be configured, but no CA certificate could be found. A CA certificate is essential.

Save the CA certificate in PEM format under the name “ca.pem” together with the XML file or upload it in the web config.

The WiFi data logger is displaying error code E21, what can I do?

Incorrect format of the ca.pem certificate. Check whether the ca.pem certificate is available in a PEM or BASE64 format. To do so, open the certificate using a text editor and check that you can see the string “-----BEGIN CERTIFICATE-----”. If you cannot see this string, the IT department or the user must explicitly export the certificate from the Radius server using BASE64, or convert it using openssl. There must be one certificate only, not a bundle, inside the file.

The WiFi data logger is displaying error code E22, what can I do?

A WPA2 Enterprise EAP-TLS connection needs to be configured, but no user certificate could be found. Save the user certificate in PEM format under the name “client.pem” together with the XML file or upload it in the web config.

The WiFi data logger is displaying error code E23, what can I do?

Incorrect format of the client.pem user certificate. Check whether the client.pem user certificate is available in a PEM or BASE64 format. To do so, open the certificate using a text editor and check that you can see the string “-----BEGIN CERTIFICATE-----”. If you cannot see this string, the IT department or the user must explicitly export the certificate from the Radius server using BASE64, or convert it using openssl. There must be one certificate only, not a bundle, inside the file.



Older generation Saveris2 logger, prior to 2016 (see type plate):

The most common reason for this error is low battery. Insert new batteries into the WiFi data logger.

If this does not solve the problem: Reset the WiFi data logger to its factory settings. To do this, press and hold down the control key for > 20 s until the display goes blank.

The WiFi data logger is displaying error code E24, what can I do?

A WPA2 Enterprise EAP-TLS connection needs to be configured, but no private key could be found. Save the private key in PEM format under the name "private.key" together with the XML file or upload it in the web config.

The WiFi data logger is displaying error code E25, what can I do?

Incorrect format of the private.key certificate. Check whether private.key is available in a PEM or BASE64 format. To do so, open the certificate using a text editor and check that you can see the string "-----BEGIN CERTIFICATE-----". If you cannot see this string, the IT department or the user must explicitly export the certificate from the Radius server using BASE64, or convert it using openssl. There must be one certificate only, not a bundle, inside the file.

The WiFi data logger is displaying the error code E26, what can I do?

There are 3 possible reasons for this error:

- 1 The access point (WLAN router) is outside the wireless range or is switched off. Check whether the access point is available. If necessary, change the location of the WiFi data logger.
- 2 The network name (SSID) stored in the WiFi data logger is incorrect. Check the network name of the WLAN network. Use the **Quick Start Guide** to create a new configuration file with the correct network name and save this onto the WiFi data logger.
- 3 The access point of the WLAN network does not use one of the following encryption methods: WEP, WPA (TKIP), WPA2 (AES, CCMP). Configure the access point so that one of the supported encryption methods is used.

The WiFi data logger is displaying the error code E32, what can I do?

The WiFi data logger has not obtained an IP address. There are 2 possible reasons for this error:

- 1 The network password is incorrect. Check the password of the WLAN network. Use the **Quick Start Guide** to create a new configuration file with the correct password and save this onto the WiFi data logger.
- 2 The access point (WLAN router) has a MAC filter or does not permit the integration of new devices. Check the settings for the access point.

The WiFi data logger is displaying the error code E35, what can I do?

The WiFi data logger has not received any reply to its test ping from the access point (WLAN router). Make sure that a ping to the gateway is allowed within the access point configuration.

The WiFi data logger is displaying error code E36, what can I do?

The DNS could not be resolved:

- 1 The access point (WLAN router) has no connection to the internet. Check the access point's internet connection.
or
- 2 The routing within the network infrastructure is not working. Check whether too many terminal devices are logged into the access point.

The WiFi data logger is displaying the error code E41, what can I do?

The WiFi data logger cannot obtain any current time from a time server (pool.ntp.org).

- 1 The access point (WLAN router) has no connection to the internet. Check the access point's internet connection.
- 2 The NTP port (123/UDP) of the access point (WLAN router) is not open. Check whether the NTP port (123/UDP) is opened.

The WiFi data logger is displaying the error code E51, what can I do?

The WiFi data logger was not able to connect to the Testo Cloud.

- 1 If the WiFi data logger has already been connected to the Testo Cloud and this connection is suddenly no longer possible: The Testo Cloud servers are not currently accessible. The servers will be monitored and should be accessible again within a few hours.
- 2 If the WiFi data logger has not yet been connected to the Testo Cloud: The TCP ports (1883 or 8883) of the access point (WLAN router) are not open. Check whether the TCP ports (1883 or 8883) are open in both directions.

The WiFi data logger is displaying error code E52, what can I do?

The data logger could not log into the Cloud because it is already logged into another account. Please log the data logger out of the existing account first.

The WiFi data logger is displaying the error code E63, what can I do?

The WiFi data logger could not send any data to the Testo Cloud.

- 1 The internet connection was interrupted during the transmission. Check whether there is a stable connection from the WiFi data logger to the access point (WLAN router). Check the access point's internet connection. The data will be transferred during the next communication cycle. Alternatively: Initiate data transmission manually by pressing the control key on the WiFi data logger.
- 2 The Testo Cloud server was not able to process the request for data storage. The servers will be monitored and should be accessible again within a few hours.

The WiFi data logger is displaying the error code E75, what can I do?

A firmware update for the WiFi data logger failed.

The internet connection was interrupted during the transmission or the data was not received intact by the WiFi data logger for other reasons. Check whether there is a stable connection from the WiFi data logger to the access point (WLAN router). Check the access point's internet connection. The data will be transferred during the next communication cycle. Alternatively: Initiate data transmission manually by pressing the control key on the WiFi data logger.

The WiFi data logger is displaying the warning message Err AccountID, what can I do?

The AccountID contained in the configuration file is not valid.

Use the **Quick Start Guide** to create a new configuration file and save this onto the WiFi data logger.

The WiFi data logger is displaying the warning message no AccountID, what can I do?

There is no AccountID in the configuration file.

Use the **Quick Start Guide** to create a new configuration file and save this onto the WiFi data logger.

The WiFi data logger is displaying the warning message no License, what can I do?

The WiFi data logger cannot be logged on because the number of WiFi data loggers permitted to log on has been exceeded or your testo Saveris 2 licence has expired.

Log off another WiFi data logger, extend or renew your testo Saveris 2 licence.

The WiFi data logger is displaying the warning message not Active, what can I do?







The WiFi data logger has been deactivated. It is not storing, and therefore not sending, any measurement data to the Testo Cloud.



Activate the WiFi data logger (under **Configuration --> WiFi data logger**) when the WiFi data logger needs to store and send measurement data again.





16 Approvals and Certification

Product	Saveris 2 T1 (2016) Saveris 2 T2 (2016) Saveris 2 T3 (2016) Saveris 2 H1 (2016) Saveris 2 H2 (2016)
Mat.-No.	0572 2031 0572 2032 0572 2033 0572 2034 0572 2035
Date	21.09.2023

i The use of the wireless module is subject to the regulations and stipulations of the respective country of use, and the module may only be used in countries for which a country certification has been granted. The user and every owner has the obligation to adhere to these regulations and prerequisites for use, and acknowledges that the re-sale, export, import etc. in particular in countries without wireless permits, is his responsibility.

Country	Comments
Australia	 E 1561
Belarus	Authorized
Brazil	<p>T1</p>  <p>T2</p>  <p>T3</p>  <p>H1</p>  <p>H2</p>  <p>Este equipamento não tem direito à proteção contra interferência prejudicial e não pode causar interferência em sistemas devidamente autorizados.</p>

Canada	<p>Contains IC : 21461-LS4WF0459</p> <p>T1, T2, T3, H2: IC: 6127B-0572203X H1: IC: 6127B-05722034 see IC Warnings</p>
China	<p>T1: CMIIT ID: 2017DJ3306 T2: CMIIT ID: 2017DJ3310 T3: CMIIT ID: 2017DJ3303 H1: CMIIT ID: 2017DJ3309 H2: CMIIT ID: 2017DJ3305</p>
Europa + EFTA	<p>CE</p> <hr/> <p> Hereby, Testo SE & Co. KGaA declares that the radio equipment type</p> <ul style="list-style-type: none"> • Saveris 2 T1 (2016) – 0572 2031 • Saveris 2 T2 (2016) – 0572 2032 • Saveris 2 T3 (2016) – 0572 2033 • Saveris 2 H1 (2016) – 0572 2034 • Saveris 2 H2 (2016) – 0572 2035 <p>is in compliance with Directive 2014/53/EU.</p> <p>The full text of the EU declaration of conformity is available at the following internet address:</p> <ul style="list-style-type: none"> • Saveris 2 T1 (2016): https://www.testo.com/testo-saveris-2-t1/p/0572-2031 • Saveris 2 T2 (2016): https://www.testo.com/testo-saveris-2-t2/p/0572-2032 • Saveris 2 T3 (2016): https://www.testo.com/testo-saveris-2-t3/p/0572-2033 • Saveris 2 H1 (2016): https://www.testo.com/testo-saveris-2-h1/p/0572-2034 • Saveris 2 H2 (2016): https://www.testo.com/testo-saveris-2-h2/p/0572-2035 <hr/> <p>EU countries: Belgium (BE), Bulgaria (BG), Denmark (DK), Germany (DE), Estonia (EE), Finland (FI), France (FR), Greece (GR), Ireland (IE), Italy (IT), Latvia (LV), Lithuania (LT), Luxembourg (LU), Malta (MT), Netherlands (NL), Austria (AT), Poland (PL), Portugal (PT), Romania (RO), Sweden (SE), Slovakia (SK), Slovenia (SI), Spain (ES), Czech Republic (CZ), Hungary (HU), Republic of Cyprus (CY).</p> <p>EFTA countries: Iceland, Liechtenstein, Norway, Switzerland</p> <hr/> <p> WEEE Reg. no.: DE 75334352</p> <hr/>

Israel	Authorized														
Japan	 211-160704 see Japan Information														
Malaysia	Authorized														
Pakistan	Authorized														
South Africa	T1: TA-2017/766 T2: TA-2017/763 T3: TA-2017/764 H1: TA-2017/762 H2: TA-2017/765														
South Korea	 T1: MSIP-CRM-te2-05722031 T2: MSIP-CRM-te2-05722032 T3: MSIP-CRM-te2-05722033 H1: MSIP-CRM-te2-05722034 H2: MSIP-CRM-te2-05722035 see KCC Warning														
United Kingdom (GB)	 <hr/>  The UK Declaration of Conformity can be found on the testo homepage www.testo.com under the product specific downloads. <hr/>														
USA	Contains FCC ID: N8NLS4WF0459 T1, T2, T3, H2: FCC ID: WAF-0572203X H1: FCC ID: WAF-05722034 see FCC Warnings														
Thailand	Authorized														
Türkiye	Authorized														
Vietnam	Authorized														
Wi-Fi-Module	<table border="1"> <thead> <tr> <th>Feature</th> <th>Values</th> </tr> </thead> <tbody> <tr> <td>WLAN Range</td> <td>100 m</td> </tr> <tr> <td>WLAN type</td> <td>LSD4WF0459-01D0</td> </tr> <tr> <td>WLAN radio class</td> <td>Accord with the standard of IEEE 802.11b/g/n</td> </tr> <tr> <td>Company</td> <td>Lierda Technology Group co., LTD</td> </tr> <tr> <td>RF Band</td> <td>2412-2472MHz</td> </tr> <tr> <td>Transmitter Power</td> <td>13.42dBm</td> </tr> </tbody> </table>	Feature	Values	WLAN Range	100 m	WLAN type	LSD4WF0459-01D0	WLAN radio class	Accord with the standard of IEEE 802.11b/g/n	Company	Lierda Technology Group co., LTD	RF Band	2412-2472MHz	Transmitter Power	13.42dBm
Feature	Values														
WLAN Range	100 m														
WLAN type	LSD4WF0459-01D0														
WLAN radio class	Accord with the standard of IEEE 802.11b/g/n														
Company	Lierda Technology Group co., LTD														
RF Band	2412-2472MHz														
Transmitter Power	13.42dBm														
EN 12830	Acc. to EN 12830 -S,T,A,C,D,1, -25...+25°C														

IC Warnings

This instrument complies with Part 15C of the FCC Rules and Industry Canada RSS-210 (revision 8). Commissioning is subject to the following two conditions:

- (1) This instrument must not cause any harmful interference and
- (2) this instrument must be able to cope with interference, even if this has undesirable effects on operation.

Cet appareil satisfait à la partie 15C des directives FCC et au standard Industrie Canada RSS-210 (révision 8). Sa mise en service est soumise aux deux conditions suivantes :

- (1) cet appareil ne doit causer aucune interférence dangereuse et
- (2) cet appareil doit supporter toute interférence, y compris des interférences qui provoquerait des opérations indésirables.

FCC Warnings

Information from the FCC (Federal Communications Commission)

For your own safety

Shielded cables should be used for a composite interface. This is to ensure continued protection against radio frequency interference.

FCC warning statement

This equipment has been tested and found to comply with the limits for a Class C digital device, pursuant to Part 15 of the FCC Rules. These limits are designed to provide reasonable protection against harmful interference in a residential installation. This equipment generates, uses and can radiate radio frequency energy and, if not installed and used in accordance with the instructions, may cause harmful interference to radio communications. However, there is no guarantee that interference will not occur in a particular installation. If this equipment does cause harmful interference to radio or television reception, which can be determined by turning the equipment off and on, the user is encouraged to try to correct the interference by one or more of the following measures:

- Reorient or relocate the receiving antenna.
- Increase the separation between the equipment and receiver.
- Connect the equipment into an outlet on a circuit different from that to which the receiver is connected.
- Consult the dealer or an experienced radio/TV technician for help.

Caution

Changes or modifications not expressly approved by the party responsible for compliance could void the user's authority to operate the equipment. Shielded interface cable must be used in order to comply with the emission limits.

Warning

This device complies with Part 15 of the FCC Rules. Operation is subject to the following two conditions:

- (1) this device may not cause harmful interference, and
- (2) this device must accept any interference received, including interference that may cause undesired operation.

Japan Information

当該機器には電波法に基づく、技術基準適合証明等を受けた特定無線設備を装着している。

KCC Warning

해당 무선 설비는 운용 중 전파혼신 가능성이 있음.



Testo SE & Co. KGaA

Celsiusstraße 2

79822 Titisee-Neustadt

Germany

Telefon: +49 7653 681-0

E-Mail: info@testo.de

Internet: www.testo.com